

MASTER LAY - OUT PLAN OF COLLEGE BUILDING OF COLLEGE BUILDING
BELONGS TO "SATYAM COLLEGE OF EDUCATION" G.T. ROAD MOGA.

TOTAL AREA OF LAND	- 35 KANAL . 8 MARLAS OR 192753 SQ.FT. OR 17913.84 SQ.MT.
COVD. AREA OF COLLEGE BUILDING AT G.F.	- 12263 SQ.FT. OR 1139.68 SQ.MT.
COVD. AREA OF COLLEGE BUILDING AT F.F.	- 11888 SQ.FT. OR 1104.83 SQ.MT.
COVD. AREA OF COLLEGE BUILDING AT 2nd.F.	- 11888 SQ.FT. OR 1104.83 SQ.MT.
COVD. AREA OF CANTEEN AT G.F.	- 421 SQ.FT. OR 39.13 SQ.MT.
COVD. AREA OF SECURITY ROOM AT G.F.	- 322 SQ.FT. OR 29.93 SQ.MT.
COVD. AREA OF SPORTS WINGS AT G.F.	- 556 SQ.FT. OR 51.67 SQ.MT.
COVD. AREA OF SERVANT ROOMS AT G.F.	- 885 SQ.FT. OR 82.25 SQ.MT.
TOTAL COVD. AREA AT ALL FLOORS	- 38223 SQ.FT. OR 3552.32 SQ.MT.

CERTIFIED THAT THE PLAN IS
TRUE TO THE SITE

H. Bansal
Satyam College of Education
Moga
SITE OWNER

ATTESTED BY :-

ਗੁਰਮਿੰਦਰ ਸਿੰਘ
ਸਰਪੰਚ
ਗਰਾਮ ਪੰਚਾਇਤ
ਘੱਲ ਕਲਾਂ (ਮੋਗਾ-2)



Plan Prepared as per Instruction of the Client

Sukhmander Singh Gill

DRAWN BY :-

Sukhmander Singh Gill
Approved Draughtsman Civil
By Municipal Committee &
Improvement Trust Moga
Gill Associates Zira Road, Moga
Mob. 98142-07638 (M) 01636-235741 (C)

EXISTING GROUND FLOOR PLAN OF COLLEGE BUILDING BELONGS TO "SATYAM COLLEGE OF EDUCATION" G.T. ROAD MOGA.

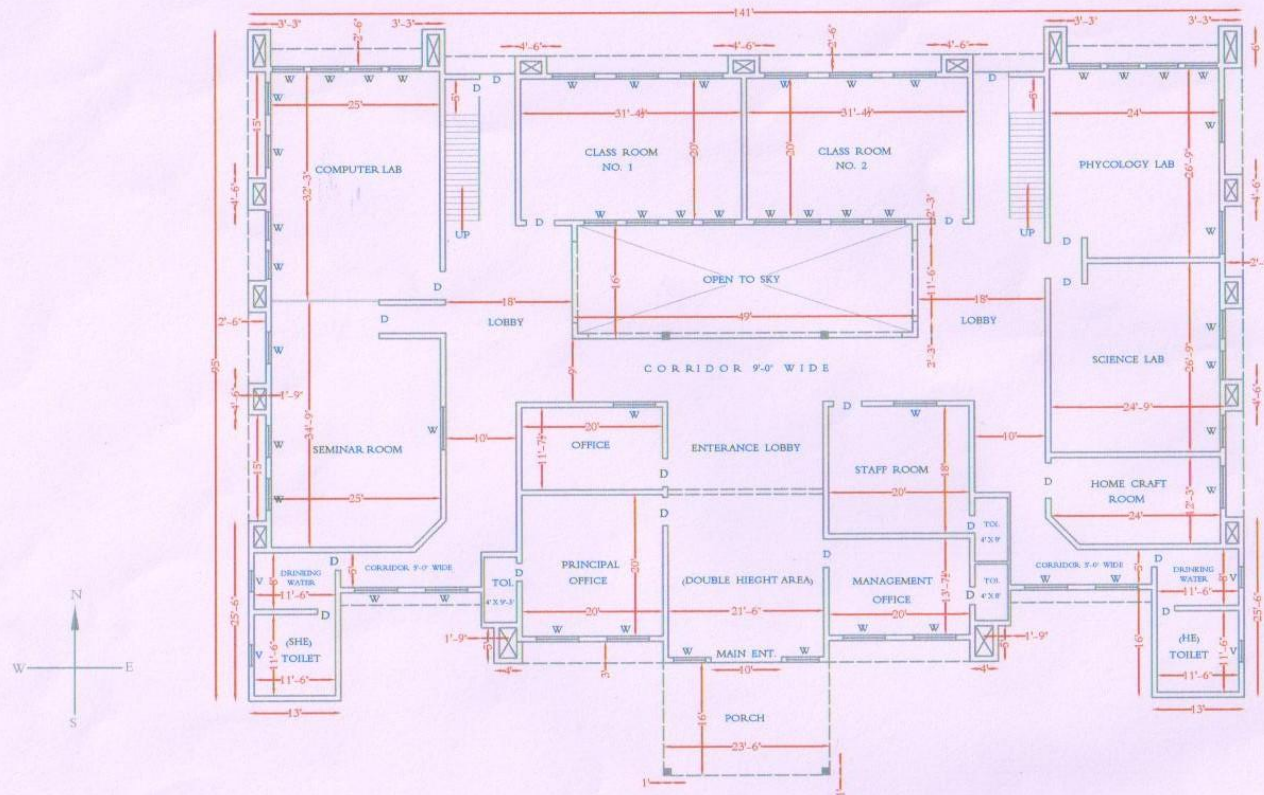

GROUND FLOOR PLAN { COVD. AREA = 12263 SQ.FT. OR 1139.68 SQ.MT.

	<p><i>H. B. B. B.</i> Satyam College of Education Moga</p> <p>SITE OWNER</p>	<p>ATTESTED BY :-</p> <p><i>ਕੋ ਸਿੰਘ</i></p> <p>ਸਰਪੰਚ ਗਰਾਮ ਪੰਚਾਇਤ ਘੱਲ ਕਲਾ (ਮੋਗਾ-2)</p>	<p>Plan Prepared as per Instruction of the Client <i>Sukhmander Singh Gill</i></p> <p>DRAWN BY :- Sukhmander Singh Gill Approved Draughtsman Civil By Municipal Committee & Improvement Trust Moga Gill Associates Zira Road, Moga Mob. 98142-07638 (M) 01636-235741 (O)</p>
--	---	---	--

EXISTING FIRST FLOOR PLAN OF COLLEGE BUILDING BELONGS TO "SATYAM COLLEGE OF EDUCATION" G.T. ROAD MOGA.

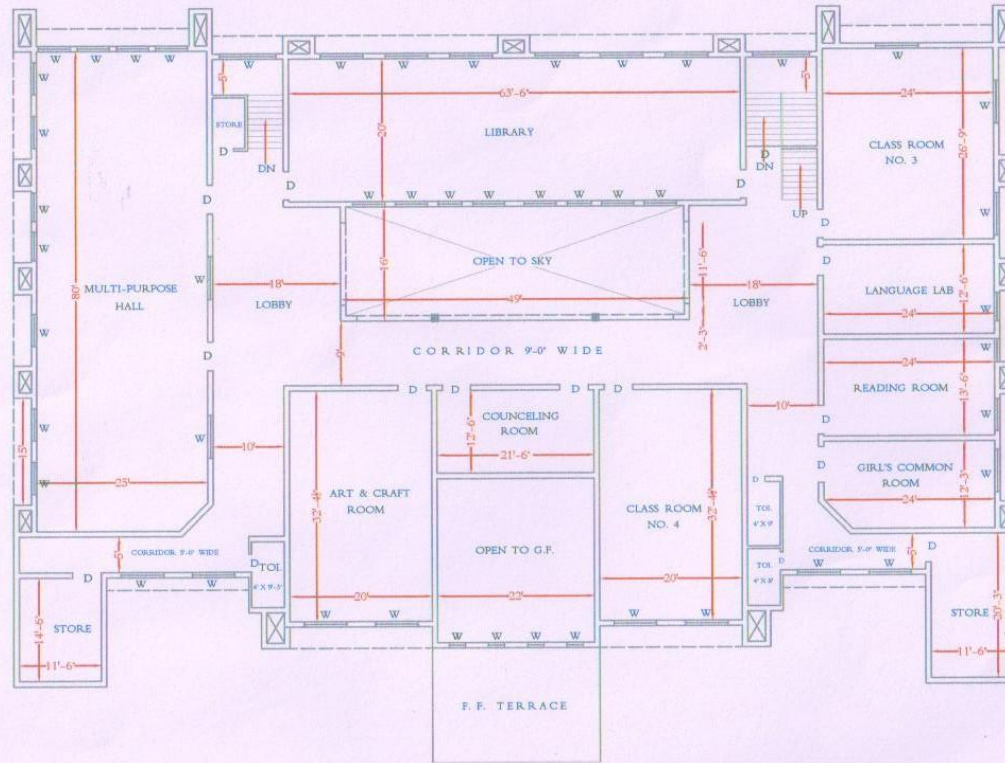

FIRST FLOOR PLAN { COVD. AREA = 11888 SQ.FT. OR 1104.83 SQ.MT.



S. Bansal
 Chairman
 Satyam College of Education
 Moga

SITE OWNER

ATTESTED BY :-

ਕੋ ਸਿੰਘ
 ਸਲਪੰਚ
 ਗਰਮ ਪੰਚਾਇਤ
 ਘੱਲੋਂ ਕਲਾਂ (ਮੋਗਾ-2)

Plan Prepared as per Instruction of the Client

DRAWN BY :- *Sukhmander Singh Gill*
 Sukhmander Singh Gill

Approved Draughtsman Civil
 By Municipal Committee &
 Improvement Trust Moga
 Gill Associates Zira Road, Moga
 Mob. 98142-07638 (M) 01636-235741 (O)

EXISTING SECOND FLOOR PLAN OF COLLEGE BUILDING BELONGS TO "SATYAM COLLEGE OF EDUCATION" G.T. ROAD MOGA.

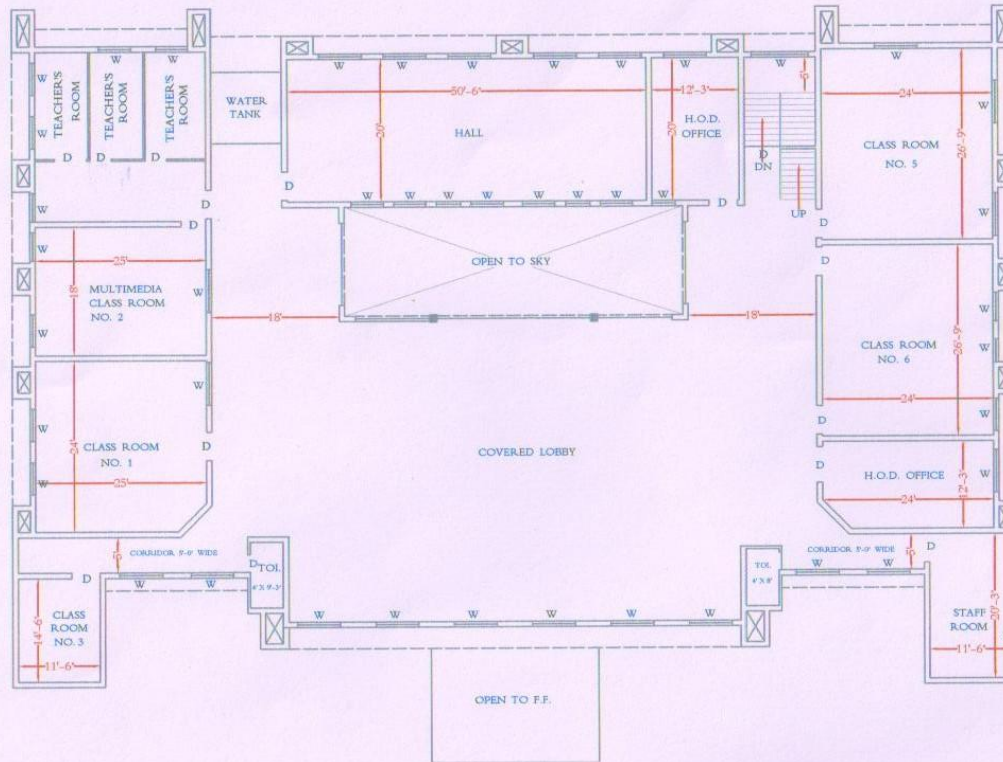

SECOND FLOOR PLAN { COVD. AREA - 11888 SQ.FT. OR 1104.83 SQ.MT.



Sukhmander Singh Gill
 Chairman
 Satyam College of Education
 Moga

SITE OWNER

ATTESTED BY :-

ਕੋ ਸਿੰਘ
 ਮਰਪੰਚ
 ਗਰਮ ਪੰਚਾਇਤ
 ਘੱਲ ਕਲਾਂ (ਮੋਗਾ-2)

Plan Prepared as per Instruction of the Client

DRAWN BY :-

Sukhmander Singh Gill
 Sukhmander Singh Gill
 Approved Draughtsman Civil
 By Municipal Committee &
 Improvement Trust Moga
 Gill Associates Zira Road, Moga
 Mob. 98142-07638 (M) 01636-235741 (O)

PLAN FOR CANTEEN SATYAM COLLEGE OF EDUCATION

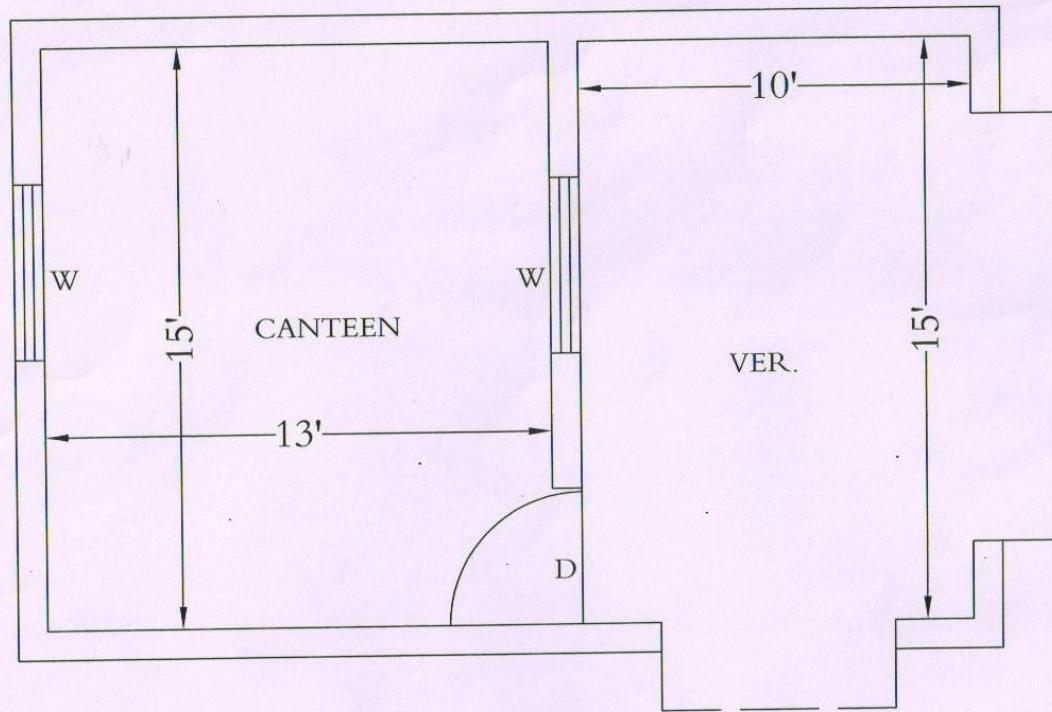

Chairman
Chairman
Satyam College of Education
Moga

ਕਰਮਿੰਦ
ਸਰਪੰਚ
ਗਰਾਮ ਪੰਚਾਇਤ
ਘੱਲ ਕਲਾਂ (ਮੋਗਾ-2)

DRAWN BY :--

Sukhmander Singh Gill

Sukhmander Singh Gill
Approved Draughtsman Civil
By Municipal Committee &
Improvement Trust Moga
Gill Associates Zira Road, Moga
Mob. 98142-07638 (M) 01636-235741 (O)

TOTAL COVD. AREA - 421 SFT. 39.13 SQ.MTS.

PLAN FOR SECURITY ROOM SATYAM COLLEGE OF EDUCATION

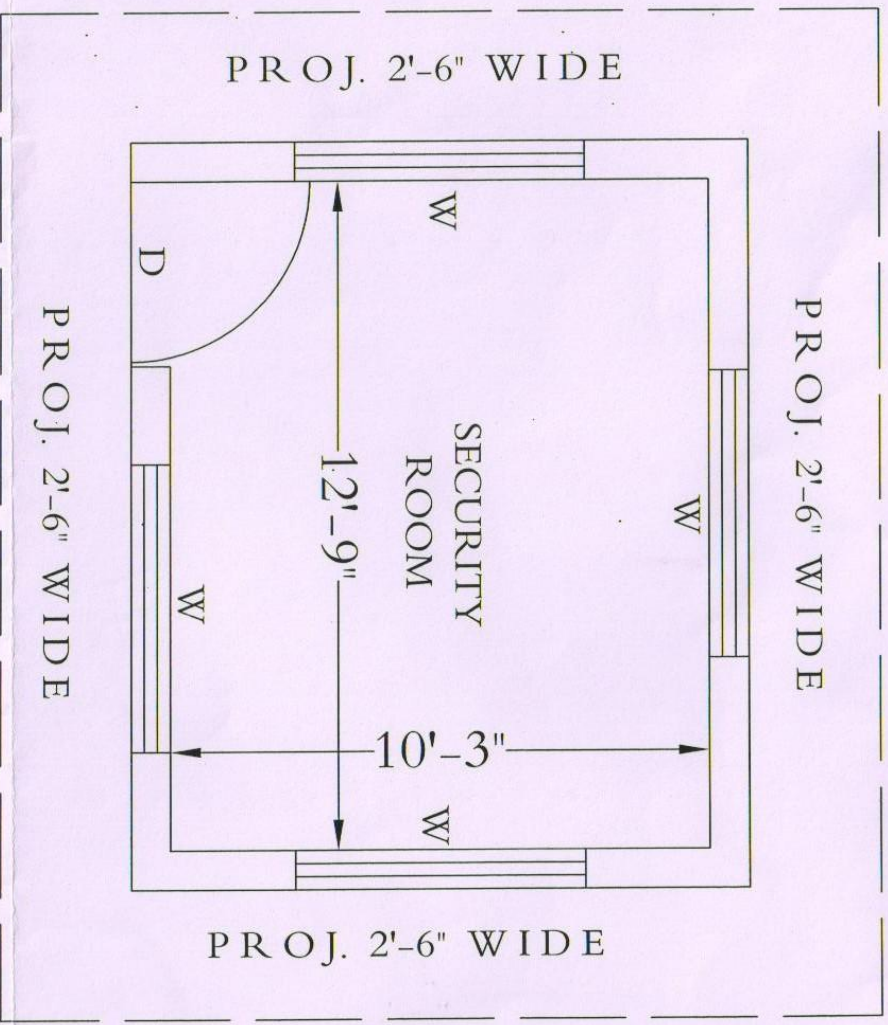

Abhimanyu
Chairman
Satyam College of Education
Moga

Dr. P. N. Singh
Head
Satyam University
Moga

DRAWN BY :-

Sukhmander Singh Gill
Sukhmander Singh Gill
Approved Draughtsman Civil
By Municipal Committee &
Improvement Trust Moga
Gill Associates Zira Road, Moga
Mob. 98142-07638 (M) 01636-235741 (C)

TOTAL COVD. AREA = 322 SFT. 29.93 SQ.MTS.

SPORTS WINGS FOR SATYAM COLLEGE OF EDUCATION

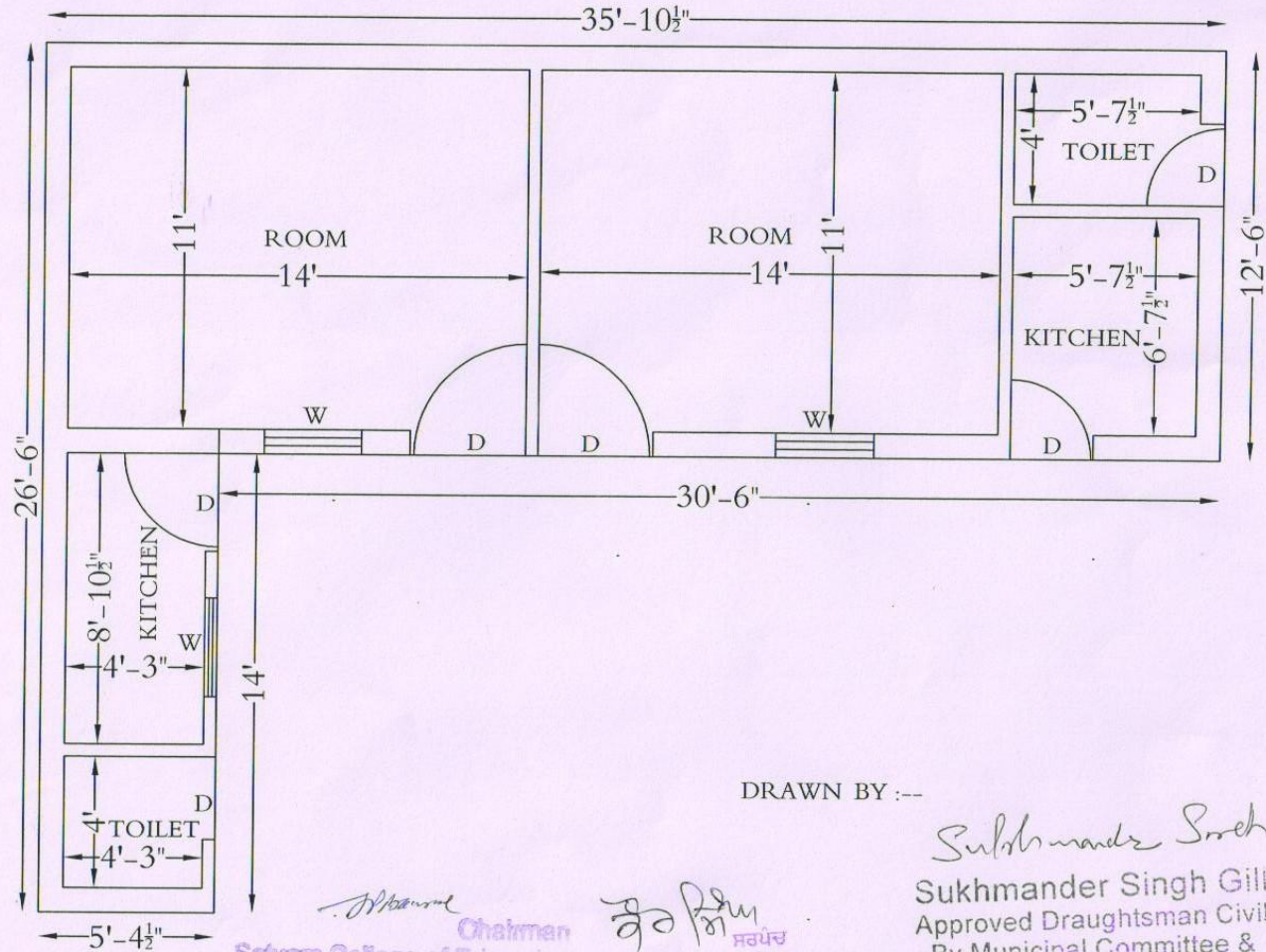

DRAWN BY :--

Sukhmander Singh Gill

Sukhmander Singh Gill
 Approved Draughtsman Civil
 By Municipal Committee &
 Improvement Trust Moga
 Gill Associates Zira Road, Moga
 Mcb. 98142-07638 (M) 01636-235741 (O)

Chairman
 Satyam College of Education
 Moga

ਸਰਪੰਚ
 ਗਰਮ ਪੰਚਾਇਤ
 ਘੱਲ ਕਲਾਂ (ਮੋਗਾ-2)

TOTAL COVD. AREA - 556 SFT. 51.67 SQ.MT.

PLAN FOR SERVANT ROOMS SATYAM COLLEGE OF EDUCATION

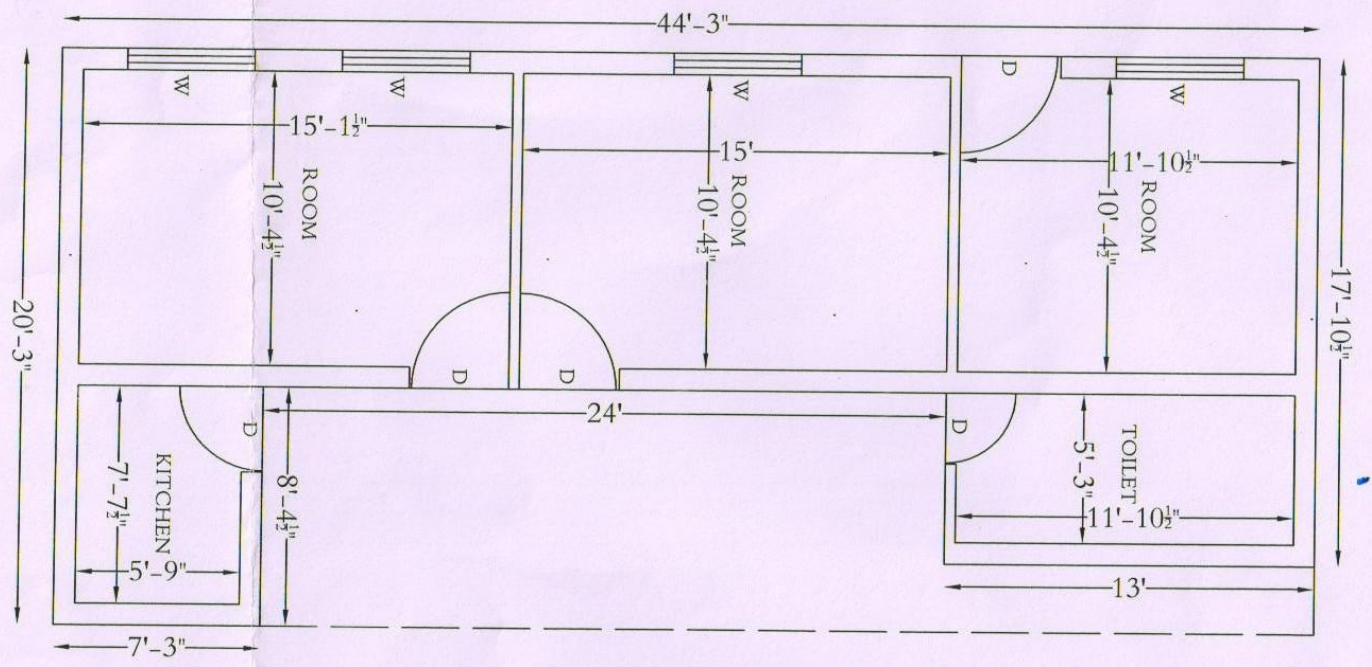

 Chairman
 Satyam College of Education
 Moga

 Draughtsman
 ਸੁਖਮੰਦਰ ਸਿੰਘ ਗਿੱਲ
 ਮੁੱਖ ਚਿੱਤਰਕਾਰ (ਭਾਗ-2)

TOTAL COVD. AREA = 885 SFT. 82.25 SQ.MTS.

DRAWN BY: 
 Sukhmander Singh Gill
 Approved Draughtsman Civil
 By Municipal Committee &
 Improvement Trust Moga
 Gill Associates Zira Road, Moga
 Mob. 98142-07638 (M) 01636-235741 (O)